



An Approach to Integrate Systems Engineering into Senior Design

Dr. George Youssef, San Diego State University

Dr. George Youssef received his Ph.D. in Mechanical Engineering from University of California Los Angeles in 2010 and joined the faculty at San Diego State University after four years appointment at California State University Northridge. His research interest is in the general area of solid mechanics with focus on nontraditional materials such as polymers, composites, and smart materials. His research contribution in dynamic properties of shock-loaded materials, interfacial strength of direct bond wafers, environmental degradation of polymers, and biomechanics of walking. Dr. Youssef has several publications in archival peer-reviewed journals. His research has been supported by National Science Foundation, Department of Defense, and private industries. Dr. Youssef was recognized in 2014 by San Fernando Engineers Council as Distinguished Engineering Educator and is one of the 2016 Society of Automotive Engineers (SAE) Ralph R. Teetor Award winners.

Vladimir Arutyunov, California State University Northridge

An Approach to Integrate Systems Engineering into Senior Design

George Youssef, Ph.D.¹ and Vladimir Arutyunov²

¹Mechanical Engineering Department, San Diego State University

²Mechanical Engineering Department, California State University Northridge

Abstract

Senior design projects are essential capstone experiences to Mechanical Engineering students that allow them to integrate and apply the knowledge they attained in all of their prerequisite courses. Generally, senior students are required to engineer a system that can be purely mechanical or interdisciplinary such as a biomedical, automotive, or aerospace system. Traditionally, Mechanical Engineering curricula focus on the specifics of each component or subsystem with no regard, or at best little regard, to the overall system requirements. On the one hand, the undergraduate thermofluid sequence of courses emphasizes the fundamentals of thermodynamics, fluid mechanics and heat transfer. While, the details of thermofluid system design are usually taught at the senior or graduate level. On the other hand, design and mechanics courses focus on teaching students the aspects of analyzing certain machine elements such as shafts, pulleys, and gears. Overall systems design courses are only available in limited graduate programs nationwide. This educational approach creates a gap in students' understanding of system level requirements; thus, issues usually arise at the interfaces between subsystems in senior design projects. The current approach in senior design courses to remedy the system interface problem is Edisonian, while engineering practice is moving towards a systematic approach to design and realization. In this paper, a basic and effective approach to integrate the fundamentals of Systems Engineering into the engineering design processes is discussed. The approach consists of developing a dynamic System Level Diagram (SLD), where students transpose the system and interface requirements onto a 2-dimensional block diagram. The SLD is constructed by arranging each component and interface using flowchart methodology, where the number of components is based on the design problem while the interfaces are defined based on physical aspects such as the underlying physics, available local and distributed manufacturing facilities, and structural boundary conditions. This systems approach was adopted by graduating mechanical engineering senior design students who elected to compete in the Society of Automotive Engineers (SAE) Aero Design Competition, during which they developed a system level diagram for their system. They initially developed a layout of the RC aircraft system, then continuously updated the system level diagram throughout the design and the realization processes. The system level diagram was proven to be instrumental during the synthesis, tradeoff, analysis, fabrication, assembly, and testing phases of the project. The system diagram was also used for management, supply chain, and quality assurance aspects of the project. Overall, students reported substantial gain in their design skills and system level understanding.

Introduction and background

The complexity of engineered mechanical systems has been increasing with the continuous integration of electronics and software. This requires recent graduates to have multidisciplinary, system-level skills. On the other hand, graduating mechanical engineering seniors lack these important skills, which created a gap between the desired skillset required by employers and those attained in the academia. This gap has been extensively discussed by the American Society of Mechanical Engineers (ASME) reports leading to the ASME ‘Vision 2030’ based on surveys of industry, recent graduates and academic professors^[1]. This skill gap is a twofold problem with its roots at the curricula and pedagogy design level.

On the one hand, the knowledge attained in the classroom is monolithic with some limited exposure to systems design, integration, and analysis, especially in the undergraduate level. Indeed, one can argue that the first exposure to ‘real life’ systems design is during senior design, but some can argue that this exposure is not sufficient or may be too late. Typically, mechanical engineering students with interest in mechanical systems design take three to five courses, depending on the number of units in the degree program and curriculum structure, to prepare them for jobs in design. These courses are Computer-Aided Design, Introduction to Manufacturing, Statics and Dynamics, Strength of Materials, and Design of Mechanical Components (referred to as Machine Design). These courses are very important in educating students on the fundamentals of engineering, mechanics, and design, where in some cases system synthesis is emphasized. In this educational paradigm, students are expected to link the chain of knowledge together with little to no guidance. Youssef and Kabo recognized this issue and proposed a new approach to teach Machine Design, where they integrated more systems design considerations as well as soft-skills such as communication^[2]. They reported significant improvement in the quality of students as the students moved into capstone courses and industry; however, this course was at the junior level and their approach requires substantial investment of professors’ time and effort. Based on the outcome of their study, Youssef and Kabo encouraged further integration of their approach into prerequisite courses such as statics, etc. Katz has discussed a similar approach but focused on a dynamics and vibrations course rather than machine design^[3]. Katz proposed an approach to bridge the gap between analytical and design thinking in general, while the approach of Youssef and Kabo emphasized the gap between systems design skills and the desired skillsets required by employers (i.e., balance between hard and soft skills). Regardless of the course in focus, these efforts are steps in the right direction and should be propagated to other cornerstone courses. It is worth noting that such integration is an ongoing effort by many professors nationwide.

On the other hand, a majority of mechanical engineering programs lack courses on Systems Engineering (SE) or Systems Design at the undergraduate level. If a course is offered, it usually lacks emphasis on systems architecture, practicality beyond requirements tracking, and interface physics and mechanics. That is to say, Systems Engineering courses, the majority of which are offered only at the graduate level, are usually taught from industrial engineering or engineering management perspectives with less emphasis on the interaction and integration of multi-physics subsystems and interfaces. Towhidnejad and Hillburn created a reference manual to help educators establish graduate level Systems Engineering programs with emphasis on system-level

competencies^[4]. Alternatively, it is important to note that many other academicians have collaborated with industry and funding agencies to remedy the lack of systems engineering knowledge in graduating seniors. In separate efforts, Lee, Sheppard, and Zender et al. discussed different approaches to integrate systems thinking into capstone projects^[5-7]. Lee reported on symbolic mathematics software tools to develop high fidelity models of complex systems in collaboration with an industry partner^[5]. This approach lacked incorporation of the practical interactions between multiple subsystems while it emphasized the mathematical modeling of each subsystem. In another attempt to collaborate with industry, Zender et al. created a multi-institutional alliance between students, faculty, industry sponsors, and workplace coaches to simulate a workplace ecosystem^[7]. They integrated multiple aspects of systems engineering such as Computer-Aided Design/Computer-Aided Manufacturing (CAD/CAM), Product Lifecycle Management, and Project Management, to name a few. They reported sixteen lessons learned from this research, but more importantly, they presented a working structure for academia/industry collaboration. Finally, Sheppard collaborated with the U.S. Department of Defense to instill system-level skills in undergraduate students by modifying elements in the curriculum^[6]. Sheppard's specific focus was on developing a systems engineering framework for multidisciplinary capstone design. In that study, the focus was on programmatic and managerial aspects rather than on interdisciplinary technical aspects. The latter is the focus of this paper.

Despite the reported candid efforts from academia and industry to graduate engineers with system-level competence, one must wonder about the locality and narrow focus. On the locality, it is obvious that the reported efforts are still limited to a few universities and such efforts are not globalized in engineering education. Although some engineering programs try to integrate systems engineering into their curricula, the emphasis is on management and not technical aspects as discussed above. Nonetheless, professors who are teaching mechanical design and mechanics classes usually map the fundamental concepts discussed in class to a system level perspective, but of course, the main emphasis is on design and analysis of components and subsystems. In short, we remain with two simple but important questions: 1) why is Systems Engineering absent from the Mechanical Engineering curriculum? and 2) why is the focus on engineering management rather than true systems and interface design? The authors believe the answers to these questions are the same, which is encompassed in the perceived complexity of systems engineering and lack of time to integrate it into curriculum-packed courses. More importantly, the limitations imposed on engineering programs in terms of number units have motivated educators to find alternative ways to deliver the same amount of knowledge without increasing the total number of units. For example, the California State University system (23 campuses, 17 of which offer engineering) has been diligently working since 2012 to reduce the requirements to only 120 semester units in an effort to reduce time-to-graduation. Alternatively, if a system design course is offered as a senior technical elective, only a small subset of students will be able to benefit from the system level knowledge. In this paper, we present a new, simple, and effective approach, the System Level Diagram (SLD), which can be easily integrated into senior design and other design courses. Senior design was selected since this course already hinges on synthesis, analysis and integration of systems. It allows students to appreciate true systems design with emphasis on subsystem interfaces while learning the fundamentals of Systems Engineering. Our approach was integrated into all aspects of the Society of Automotive Engineers (SAE) Aero Design competition from requirements gathering to product delivery as

shown in **Figure 1**, which shows that the System Level Diagram was used extensively in each step of design as well as in project management. **Figure 1** is a modified representation of the engineering design process, where documentation and reporting are explicitly integrated in each step of the process rather than an implied step (see Ref [2] for comparison). Additionally, the modified diagram augments the design cycle with project management. **Figure 1** should not be viewed as modification of the engineering design cycle; rather it is a graphical representation to clearly elucidate the integration of the SLD in design. It is important to note that the authors believe that offering a System Design and Analysis course would be the ideal solution, however such approach would increase the number of units or limit student exposure.

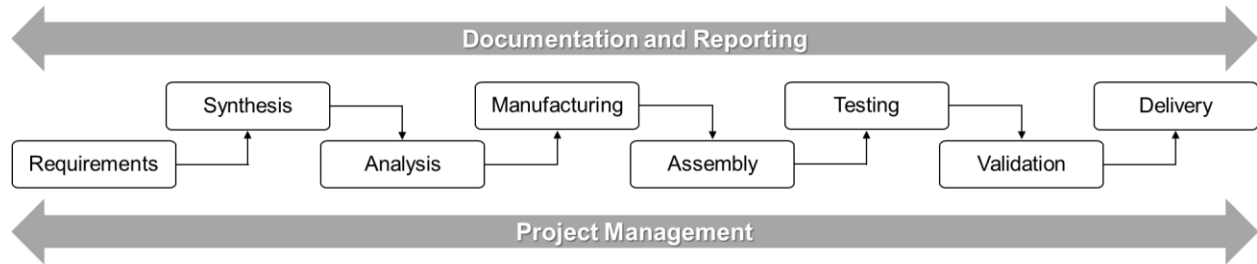

Figure 1: Integration of System Level Diagram in all phases of systems design.

Approach

The objective of this paper is to report on a simple yet effective approach to instill system-level understanding and skills in Mechanical Engineering graduating seniors while embracing the technical rigor required for systems design. Our approach is based on the development of a system level diagram that includes all of the subsystems and components with specific focus on component-to-component and component-to-subsystem interfaces. Each component is represented as a black box, where the responsible development team of engineering students performs the analysis and design decisions using external tools of choice. The students then communicate with each other between adjacent components to ensure ‘form, fit and function’ of the component, its subsystem, and eventually the entire system. This, in turn, preserves the integrity of the design process and design tools while providing the ability to track the system’s development at each stage of design. The uniqueness of this approach is its broad utility in all of the aspects of a project as discussed in the previous section (**Figure 1**). The System Level Diagram (SLD) can be created for any purely mechanical, electromechanical, or measurement system with granularity to the level of mechanical fasteners and electrical connectors. It is important to note that 1) SLD is a dynamic tool and is expected to be reiterated as the design cycle progresses and 2) SLD contextualizes the entire system as a 2D representation placing emphasis on human resource interaction and communication. The latter is especially important when multiple task-based groups work on different aspects of the project. Additionally, since the system is now easily visualized, the discussion about manufacturability between different subsystem groups takes a front seat.

The realization of the System Level Diagram is divided into two symbiotic steps, where system and requirements decomposition takes place first and system development/composition happens

thereafter. **Figure 2** shows a schematic representation of the system and requirements decomposition step, where all necessary subsystems are identified and associated functional and performance requirements are extracted and listed. The reliance on the system requirement documents as well as other engineering reports and research is inherently embedded in this step of system decomposition, where the functional and performance requirements are extracted from the requirement documents while the identification of subsystems is based on background engineering knowledge and experience. Additionally, at this early step of system development, students are required to define the interfaces between subsystems to meet the overall objectives of the system. This plays a crucial role in up- or down-selection of subsystems during initial trade-off studies. At the outset of the system and requirements decomposition step, there are four Systems Engineering lessons that are taught to the students. These lessons are:

- 1- The system must be decomposed into smaller separate but integrated subsystems;
- 2- Requirements and specifications must flow throughout the entire system architecture (up, down, left and right, i.e., interfaces);
- 3- Collaboration is demanded between subsystems and development teams; and
- 4- Morphing of development groups mirrors the system architecture.

In addition, technical details are integrated in the first step, when students carefully examine the technical viability of each subsystem. Students with limited or no knowledge about the system-in-question start to gain appreciation and understanding of the expected outcomes as well as the plan to achieve those outcomes. Important to note here is that the instructor-in-charge did not spend countless hours on introducing Systems Engineering development principles. Rather, the professor explained the mechanics and benefits of creating the system level diagram. The implied pedagogical benefits are that additional encounter hours were not required (number of academic units remains constant), preparation time is minimized, and system development started at the onset of the senior design course.

Once the high-level decomposition step is complete, the development teams contextualize each subsystem into components and interfaces (**Figure 3**). At the onset of the system composition step, one main reference component is identified, to which all other subsystems and components will be attached or grounded.

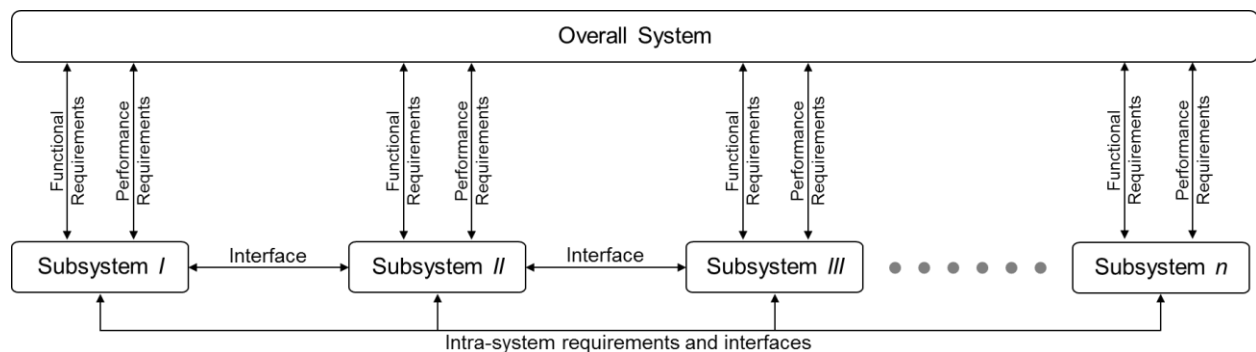

Figure 2: First phase of System Level Diagram construction.

The reference component should be selected with care, such that all the components (or at least majority of the components) are physically or remotely connected to it. For example, the

fuselage or chassis can be the reference component when developing a system level diagram for an aircraft or automobile, respectively. Generally, each component is represented by a box, which is connected to one or more other components using arrows as connecting lines. The direction of the arrows signifies the dependency, source/sink relationship, and assembly direction. Each connecting line represents an interface, where each interface must be clearly defined. For example, if the connecting line embodies a mechanical interface, it must specify whether mechanical fasteners, welds, glued joints, or other interface mechanism will be considered. Similarly, when defining an electrical connection, it must be clearly identified by listing the signal (e.g., power or control) and connector (e.g., BNC, MOLEX) types. At the early stages of system development, when the exact type of interface is not yet decided, all considered options should be listed on the connecting lines until the final trade-off study is completed. It is important to note that as design analyses take place and final decisions are made, the system level diagram is iterated to reflect the development.

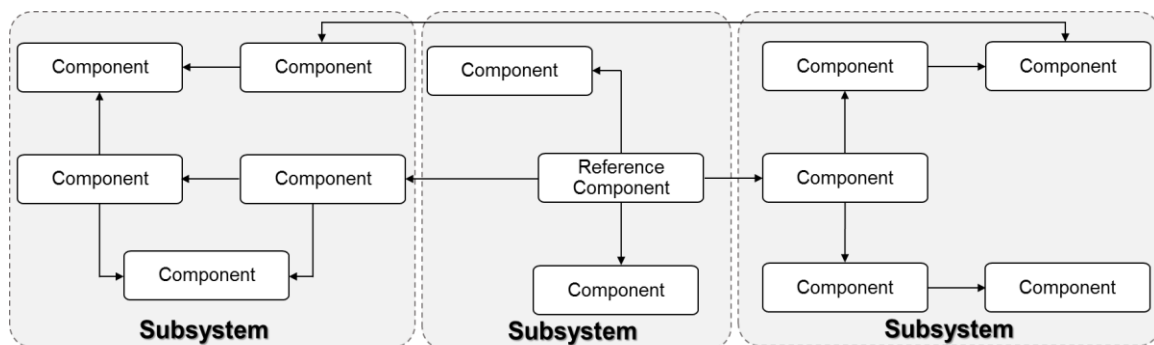

Figure 3: Final phase of System Level Diagram construction.

The parallelization between updating the system diagram and the engineering design process ensures that students are technically developing while gaining system-level skills. The realized outcomes of the system composition phase are:

- 1- In-depth technical analysis of each component's and subsystem's performance;
- 2- Informed trade-off studies for each component as an integral part of the system;
- 3- Real-time evaluation of resources (i.e., time, money, human, etc.) as the system develops;
- 4- Assurance that when the system is realized, it meets Specific, Meaningful and Measurable goals (referred to in industry as SMM); and
- 5- Quantification of risk and mitigation plans (e.g., multiple options for an interface).

Thus, the System Level Diagram approach is not only integrated within the synthesis and analysis phases, but it also serves as a team integration tool that compels students to discuss and communicate together on regular basis. Additionally, it can be used during procurement and manufacturing by setting ordering and fabrication plans since it shows dependency relationships between all components of the system. The management team can also use the system level diagram to shift resources between subsystems and tasks as the visual aspects of the diagram show the concentration of resource demand. Finally, the system level diagram, along with engineering drawings and models, can be used during assembly. In short, the system level diagram approach is a global technical and managerial tool in the senior design enterprise and engineering firm in general as shown in **Figure 4**. An example of the development and utilities

of the system level diagram will be demonstrated in the next section. To emphasize, the steps used in the following examples can be easily integrated in the synthesis and analysis of other systems.

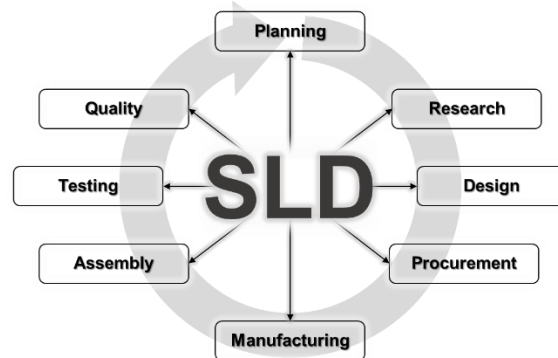

Figure 4: Integration of the system level diagram in all aspects of engineering project.

Results and discussion









Figure 5 shows the system level diagram developed by Mechanical Engineering senior design students at California State University Northridge in response to the Society of Automotive Engineers annual international Aero Design competition. Following the approach discussed in the previous section, students first read the competition rules and conducted research to identify all the subsystems and components required to realize a radio-controlled small-scale aircraft. They then started by naming the six major subsystems: propulsion, wing, tail, fuselage, landing gear, and controls. The students cross-referenced the competition rules and published research for each subsystem in an effort to create the corresponding design envelope (see [2] for discussion about design envelopes). At this point, the system and requirements decomposition phase commenced and the first version of the system level diagram was constructed. This simple, first version consisted of only six boxes connected together that represent the main subsystems previously identified. Subsequent versions evolved according to the following steps.

- 1- Drawing platform was chosen that allowed multiple users to collaborate simultaneously and remotely. The platform also supported export of the final system level diagram to different digital formats to allow for high-quality dissemination and printing. The team decided that Google Drawings was a suitable platform.
- 2- Each component was represented by a box and each connection (mechanical or electrical) was represented by a line with an arrowhead. As understanding matured, lines were upgraded to boxes (or vice versa) if the change was deemed necessary and logical based on the design requirements.
- 3- The fuselage was selected to be the reference component to which all subsystems were physically attached. This was the main structural ‘source’ component.
- 4- The diagram was arranged to represent a side view of the aircraft, where the propulsion subsystem was placed on one side of the fuselage and the tail on the opposite side. The

wing was placed above the fuselage and the landing gears were located below. The controls subsystem was integrated throughout the diagram.

- 5- The team identified all the components in each subsystem and mechanical and electrical connections were proposed and later designed based on interface and performance requirements.
- 6- Each subsystem group created a subsystem level diagram, which was then integrated into the overall aircraft system level diagram.
- 7- Each ‘sink’ component was limited to one incoming mechanical connection from each ‘source’ component. No limitations were imposed on the number of electrical connections. A ‘source’ component may have multiple outgoing mechanical connections, but must only have one incoming mechanical connection. This rule resemble the main technical interface requirements.
- 8- A list of mechanical connections (**Table 1**) was compiled and made available to every subsystem group. The list of connection types was not meant to be exhaustive, but rather it included those available to the team. This motivated the team to learn about the supply chain and resources available in or around the university.

Table 1: List of mechanical connections considered during synthesis and analysis.

	Bolted Connection		Glue
	Pinned Connection		Padded Servo Tape
	Interlocking Components		Hook and Loop Tape
	Flexure Hinge		Threaded Connection

- 9- Each connecting line (represented by arrows as discussed before) between two adjacent components was initially assigned multiple mechanical connection options. These options were then evaluated and analyzed to down-select the most appropriate connection that satisfied all requirements.
- 10- Color-coded lines were used to easily distinguish between different connection types.

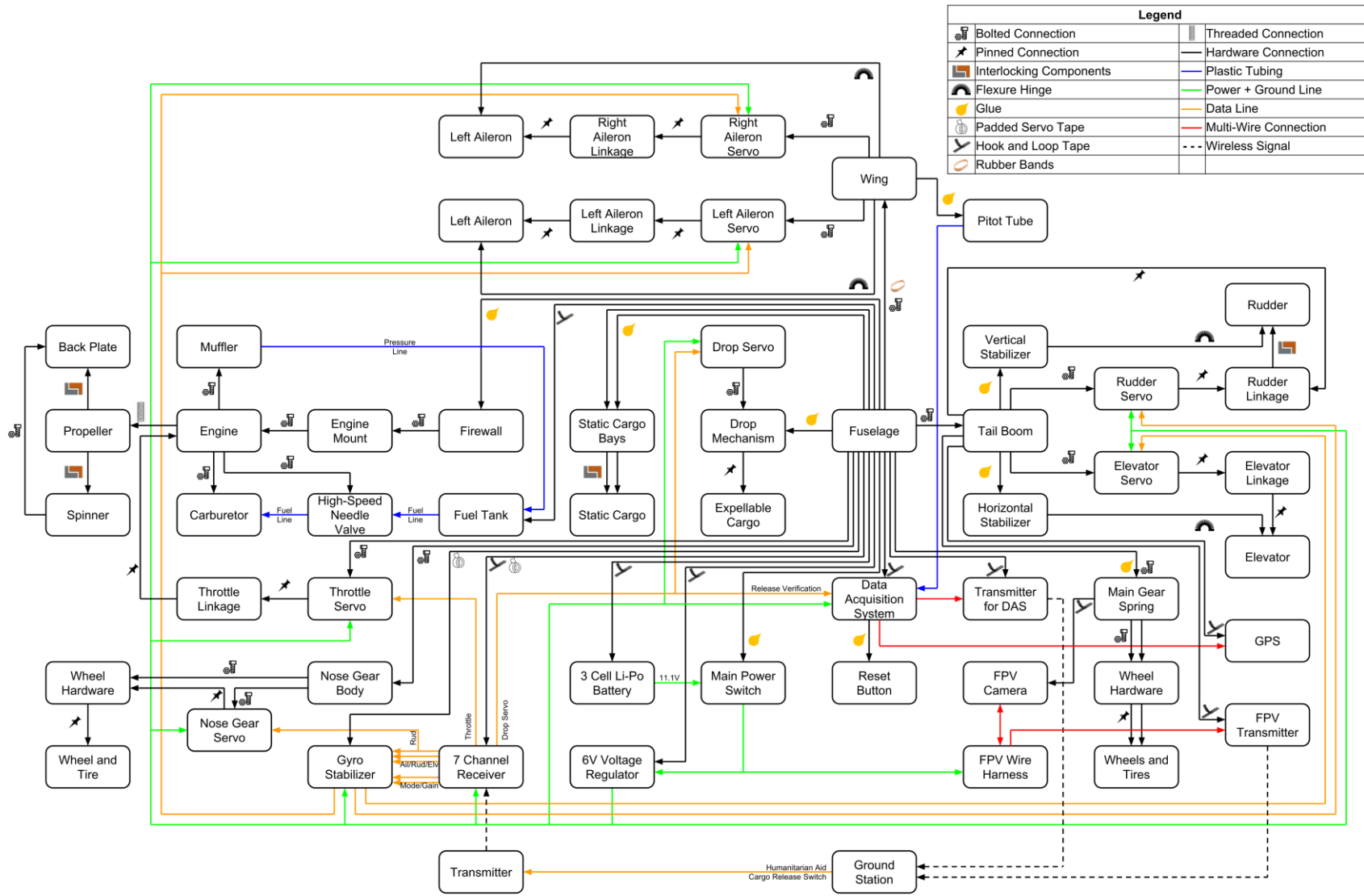

Figure 5: Model RC aircraft System Level Diagram developed by California State University Northridge students.

Once the system level diagram was finalized, which coincided with the conclusion of the system analysis, it was then used during subsequent project phases as illustrated in **Figure 4**. First, the diagram was leveraged during the design for manufacturing phase, when the manufacturability of each component was reviewed based on its placement in the diagram as well as its interface and functional requirements. Second, a master order list was created and procurement was done accordingly. A manufacturing timeline was also developed based on the component dependency relationships as illustrated in **Figure 5**. It is important to note here that such dependencies would be lost or hard to realize without the diagram. Finally, the diagram was used during assembly and documentation. The team did extremely well in the competition, scoring first place in the design presentation event and third place overall.

In addition to the strong placement in the competition, two major educational impacts were attributed to the construction and utility of the system level diagram. *First*, the diagram helped students to learn and own their role within the team and within the system quickly and comprehensively. The usefulness of the diagram was not immediately evident to all students; as the design process progressed, the level of appreciation increased rapidly. With the advent of the system level diagram, team members understood which components they had to interface with and account for in their engineering decision-making long before there was even the first CAD model of a single component. In short, the development of the system level diagram helped many students with no aerospace engineering background to quickly integrate into the team and realize the big picture. *Second*, the system level diagram's inclusion into the design and realization processes made for better systems engineering practices among students with little or no prior exposure to 'systems thinking'. The construction of the system level diagram urged students to discuss and resolve the technical details of each component and each connection before finalizing them on the diagram. The nature of the system level diagram tool is such that by requiring students to develop the diagram, it facilitated the system-level design process. Since the system level diagram is a representation of the functional relationships among the constituents of the system, the actions of developing the diagram contributed to the actions of designing the system itself.

Conclusion

The students at California State University Northridge used the system level diagram during their senior design course and were able to demonstrate system-level competence when faced with a realistic systems engineering problem. The system level diagram aided students in maturing both their hard and soft skills. Students used the diagram to enhance their system-level technical understanding during every phase of system development (research, synthesis, trade-offs, analysis, manufacturing, and assembly). Students were also able to better manage their resources, plan for system realization, build and maintain team cohesion, engage in meaningful technical dialogue, and report and present on their system in a truly system-level context. The value of the system level diagram approach in capstone engineering courses, and in system engineering in general, is its capacity to drive students to learn the fundamentals of systems engineering simply by requiring them to develop a system level diagram effectively. By using this approach, the students at California State University Northridge were able to graduate as mechanical engineers trained to think, design, and operate using system-level skills.

Bibliography

- [1] Kirkpatrick, A., & Danielson, S., *ASME VISION 2030'S RECOMMENDATIONS FOR MECHANICAL ENGINEERING EDUCATION*. Paper presented at 2012 ASEE Annual Conference and Exposition
- [2] Youssef, G., & Kabo, J. M., *Machine Design: Redesigned* Paper presented at 2015 ASEE Annual Conference and Exposition
- [3] Katz, R., *Integrating Analysis and Design in Mechanical Engineering Education* Procedia CIRP, Volume 36, 2015
- [4] Towhidnejad, M., & Hillburn, T., *An Overview of GRCSE: Graduate Reference Curriculum for Systems Engineering* Paper presented at World Congress on Engineering Education 2013
- [5] Lee, T., *Design Education in Transformation: Leading Colleges and Vendors Collaborate to Tackle an Age-old Problem* SAE International, 2010
- [6] Sheppard, K., *SE Capstone: Implementing a Systems Engineering Framework for Multidisciplinary Capstone Design* Systems Engineering Research Center, Stevens Institute of Technology, 2011
- [7] Zender, F., et al., *Aerospace Partners for the Advancement of Collaborative Engineering (AerosPACE) – Connecting Industry and Academia through a Novel Capstone Course* Paper presented at The International Conference on E-Learning in the Workplace, 2014